

Features

- 36-inch minimum base cabinet.
- Single bowl.
- 9-1/2-inch depth.
- No faucet holes.
- Offset drain increases workspace in the sink and storage space underneath.
- Includes K-5196 bottom sink rack.
- Includes cutout templates and installation clips.

Material

- KOHLER Neoroc® composite is durable and built to withstand day-to-day cleaning tasks.
- Matte finish offers rich, dimensional color.
- Solid color throughout the sink.
- Heat resistant up to 750 degrees F.
- Scratch, stain, chip, and thermal-shock resistant.

Installation

- Under-mount
- Easy to install in a one-person, single-day project.

Recommended Products/Accessories

K-9000 P-Trap
K-5192 Small stainless steel sink rack for K-8206
K-6377 Sponge Caddy
K-6378 Kitchen Brush Caddy
K-6379 Kitchen Squeegee
K-6382 Disinfecting Wipes Dispenser
K-6383 Soap Dispenser
K-8618 Paper Towel Holder
K-8619 Flexible Kitchen Mat
K-8624 Dish Scraper
K-8801 Sink Strainer
K-8799 Sink Strainer

Components

Product includes:
K-5196 Sink Rack



Codes/Standards







CSA B45.5/IAPMO Z124

KOHLER® Neoroc® Sinks Lifetime Limited Warranty

See website for detailed warranty information.

Available Colors/Finishes

Color tiles intended for reference only.

Color	Code	Description
	CM6	Matte White
	CM7	Graphite
	CM1	Neoroc® Matte Black
	CM2	Neoroc® Matte Brown
	CM3	Matte Toupe
	CM4	Matte Grey
	CM5	

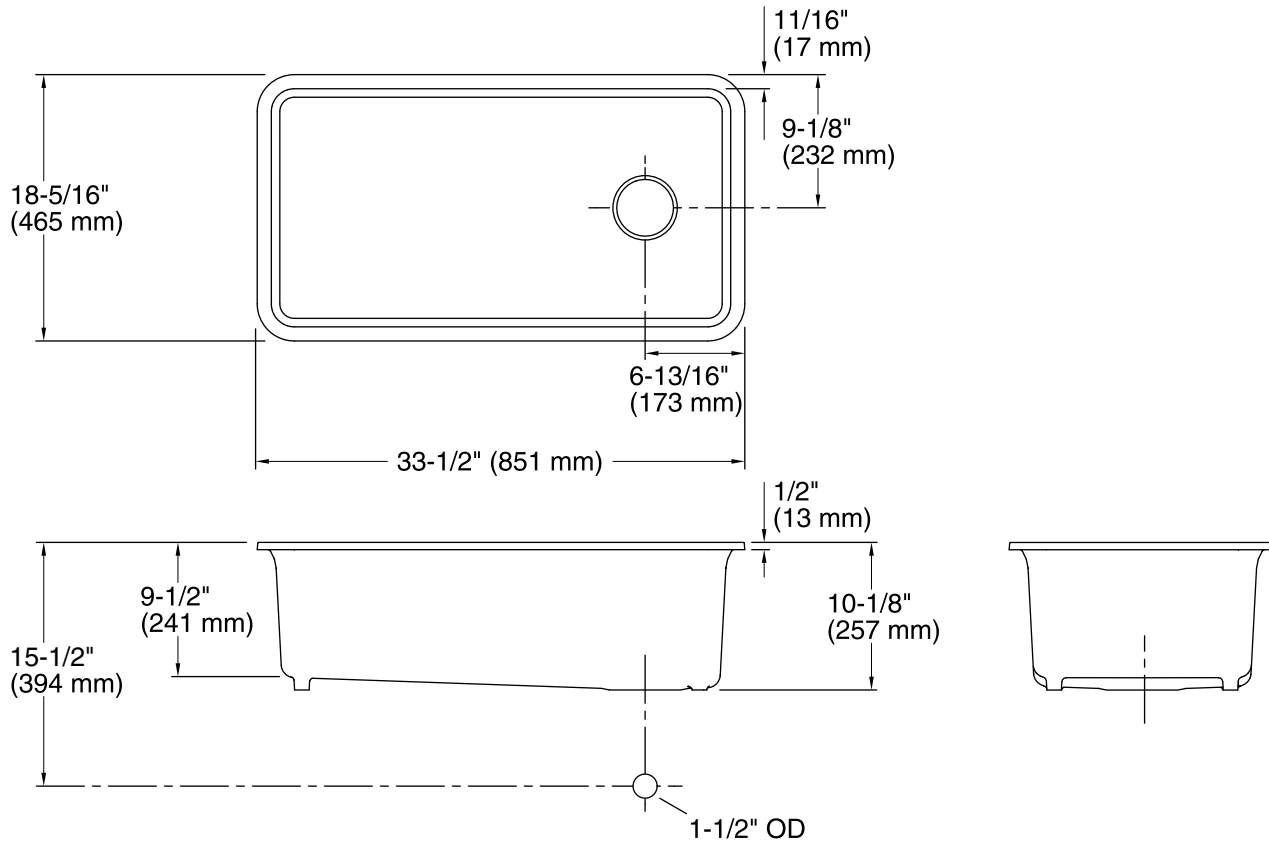

Technical Information

All product dimensions are nominal.

Bowl configuration:	Single
Installation:	Under-mount
Min. base cabinet width:	36" (914 mm)
Bowl area (Only):	Length: 30-9/16" (777 mm) Width: 15-3/8" (391 mm) Bowl depth: 9-1/2" (241 mm) Water depth: 9-1/2" (241 mm)
Drain hole:	3-7/8" (98 mm)
Template:	1256394-7, required, included

Notes

Install this product according to the installation instructions.

Allow a minimum of 2" (51 mm) clearance around the sink rim for clip attachment.